

SINGER
518/538/514/513/533

**Parts
List**

SINGER

500

series machines

518 538 514 513 533

From the library of: Diamond Needle Corp

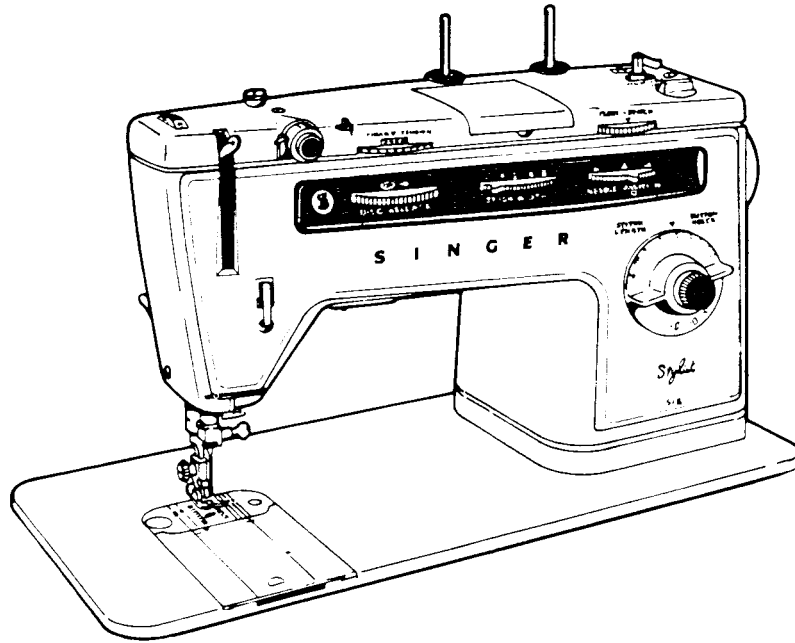

518 Machine

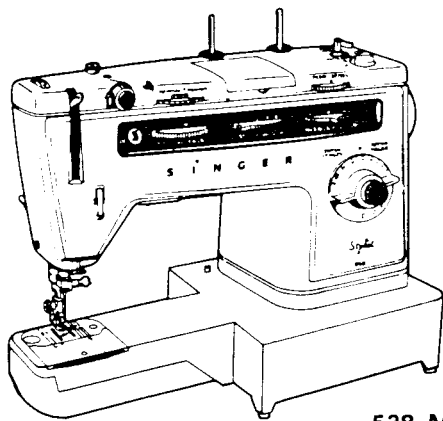

538 Machine

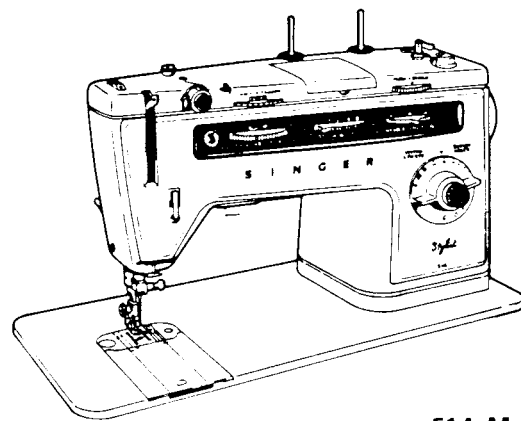

514 Machine

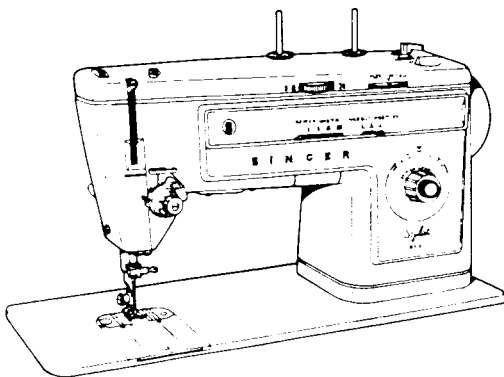

513 Machine

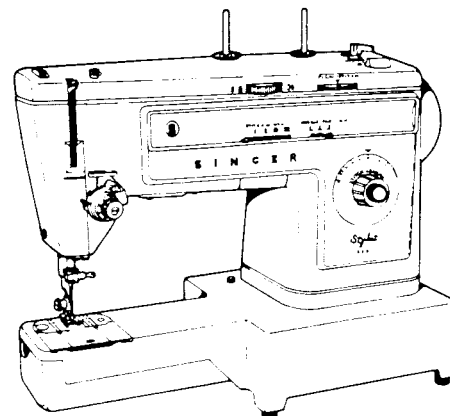

533 Machine

PROPERTY OF THE SINGER COMPANY

This is a private and confidential communication to and for the use of only the employees of The Singer Company and its affiliated companies. Reproduction, sale, distribution, or publication thereof to public is forbidden.

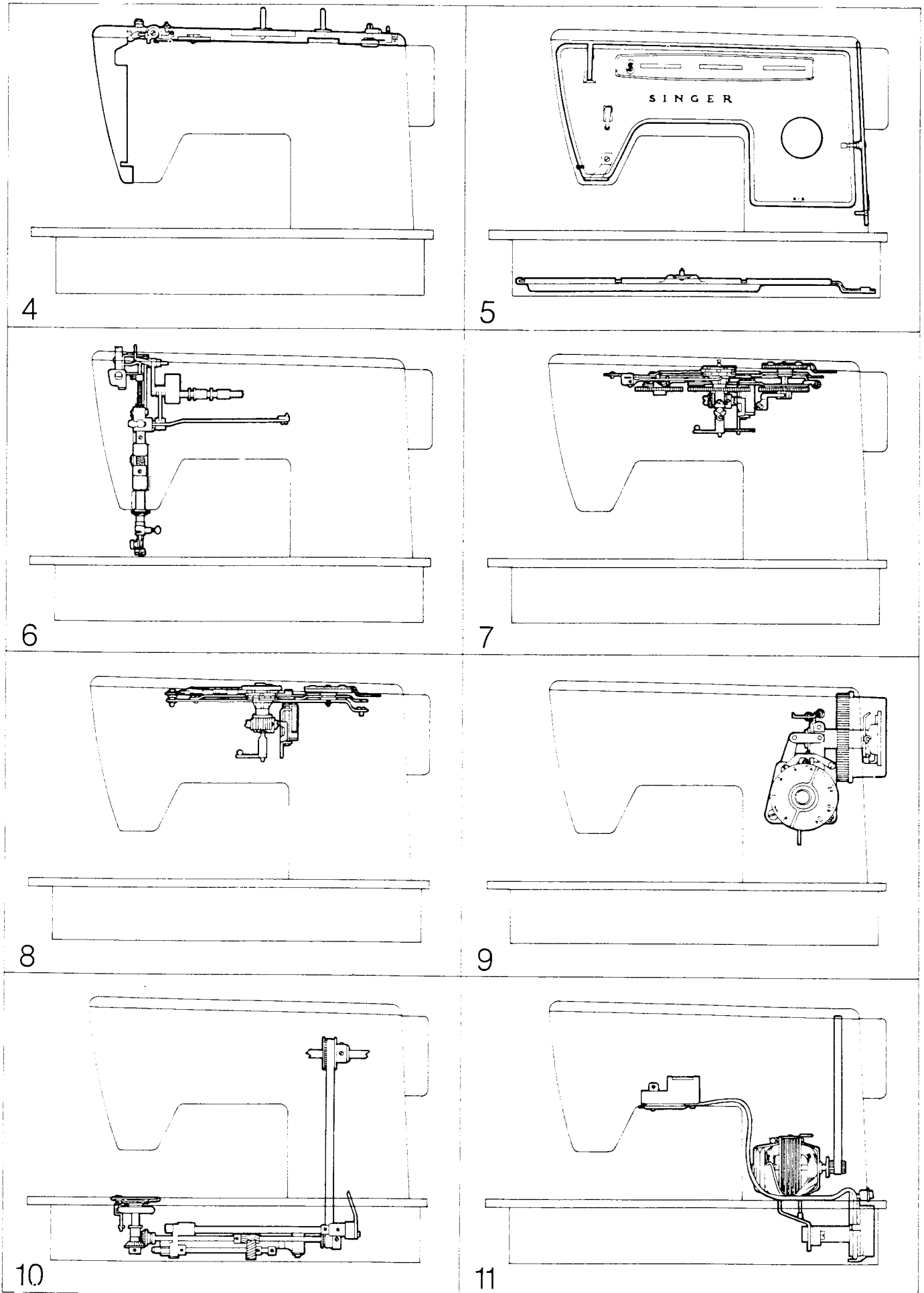

From the library of: Diamond Needle Corp

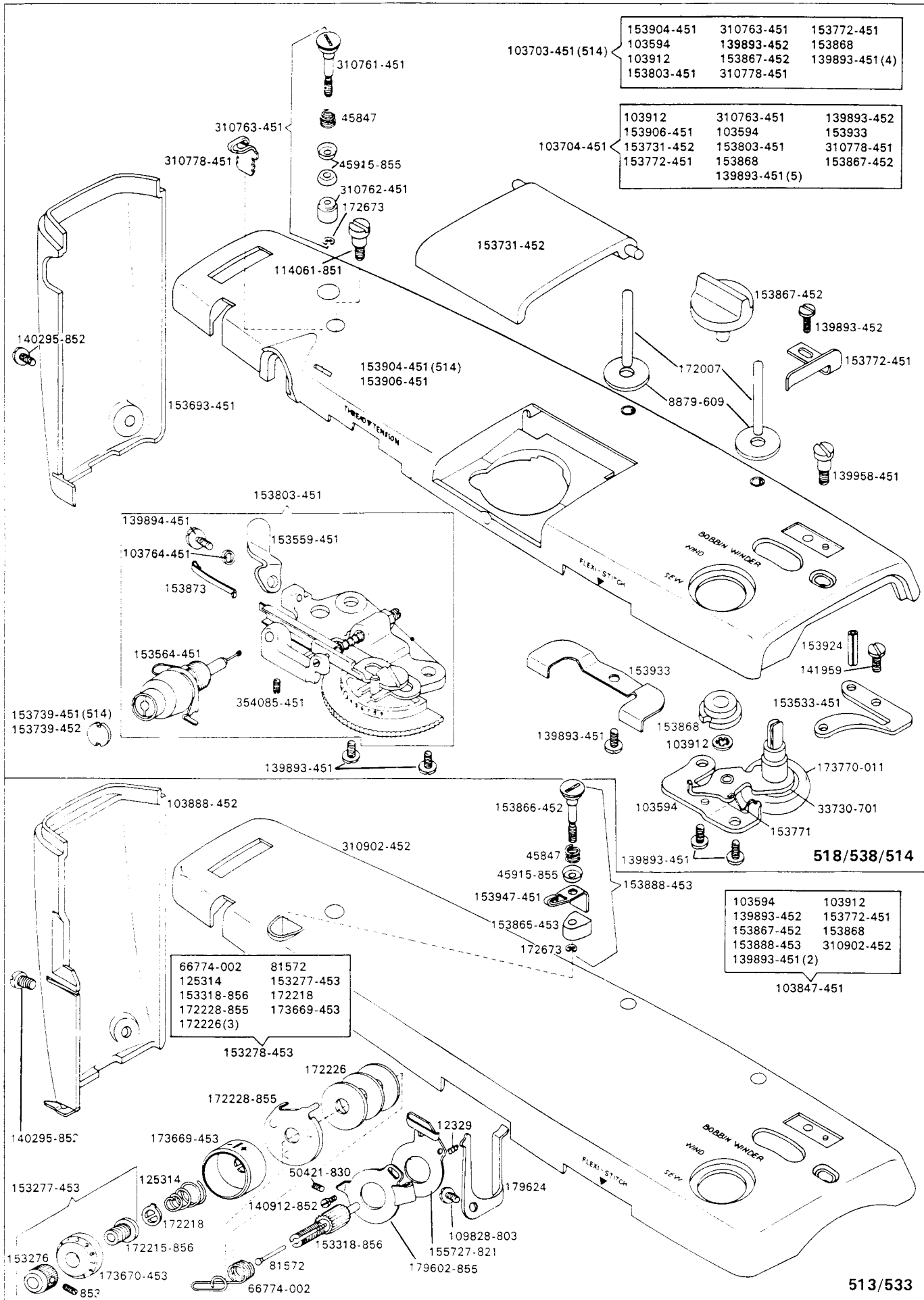

153904-451	310763-451	153772-451
103594	139893-452	153868
103912	153867-452	139893-451(4)
153803-451	310778-451	

103912	310763-451	139893-452
153906-451	103594	153933
153731-452	153803-451	310778-451
153772-451	153868	153867-452
	139893-451(5)	

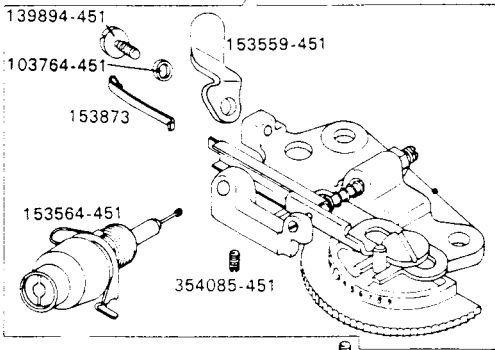

66774-002	81572
125314	153277-453
153318-856	172218
172228-855	173669-453
172226(3)	

103594	103912
139893-452	153772-451
153867-452	153868
153888-453	310902-452
139893-451(2)	

From the library of: Diamond Needle Corp

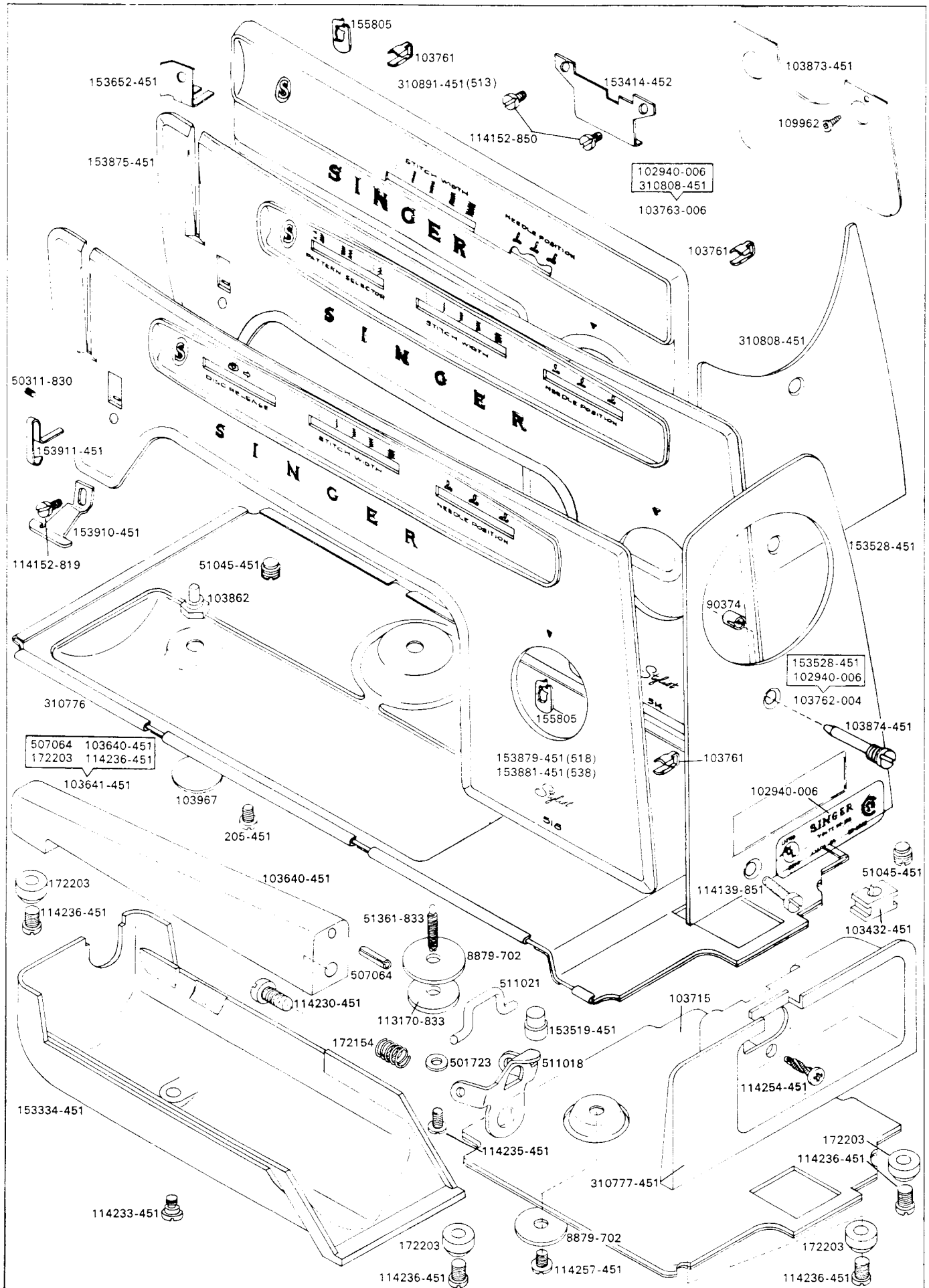

From the library of: Diamond Needle Corp

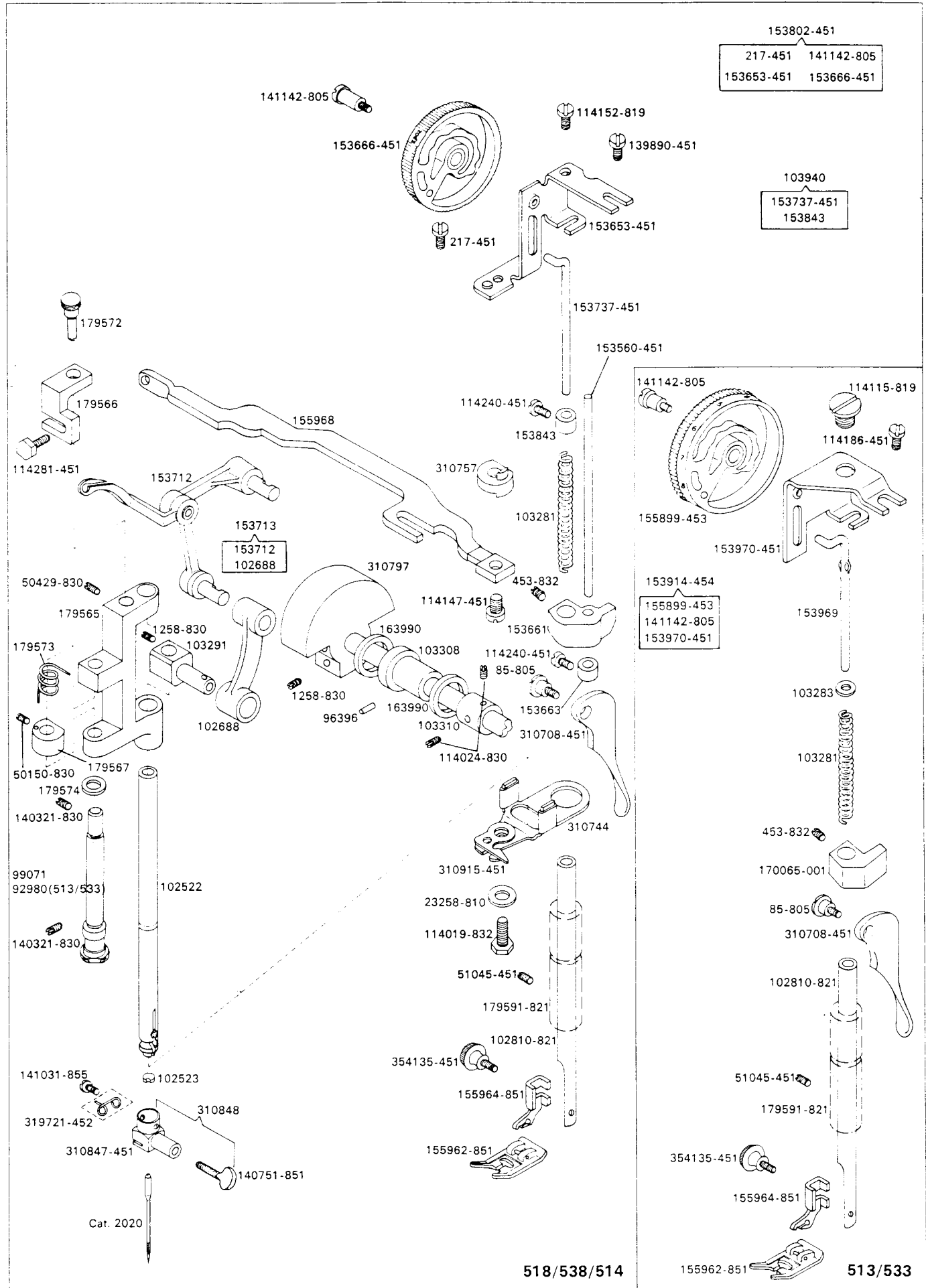

Cat. 2020

518/538/514

155962-851

513/533

From the library of: Diamond Needle Corp

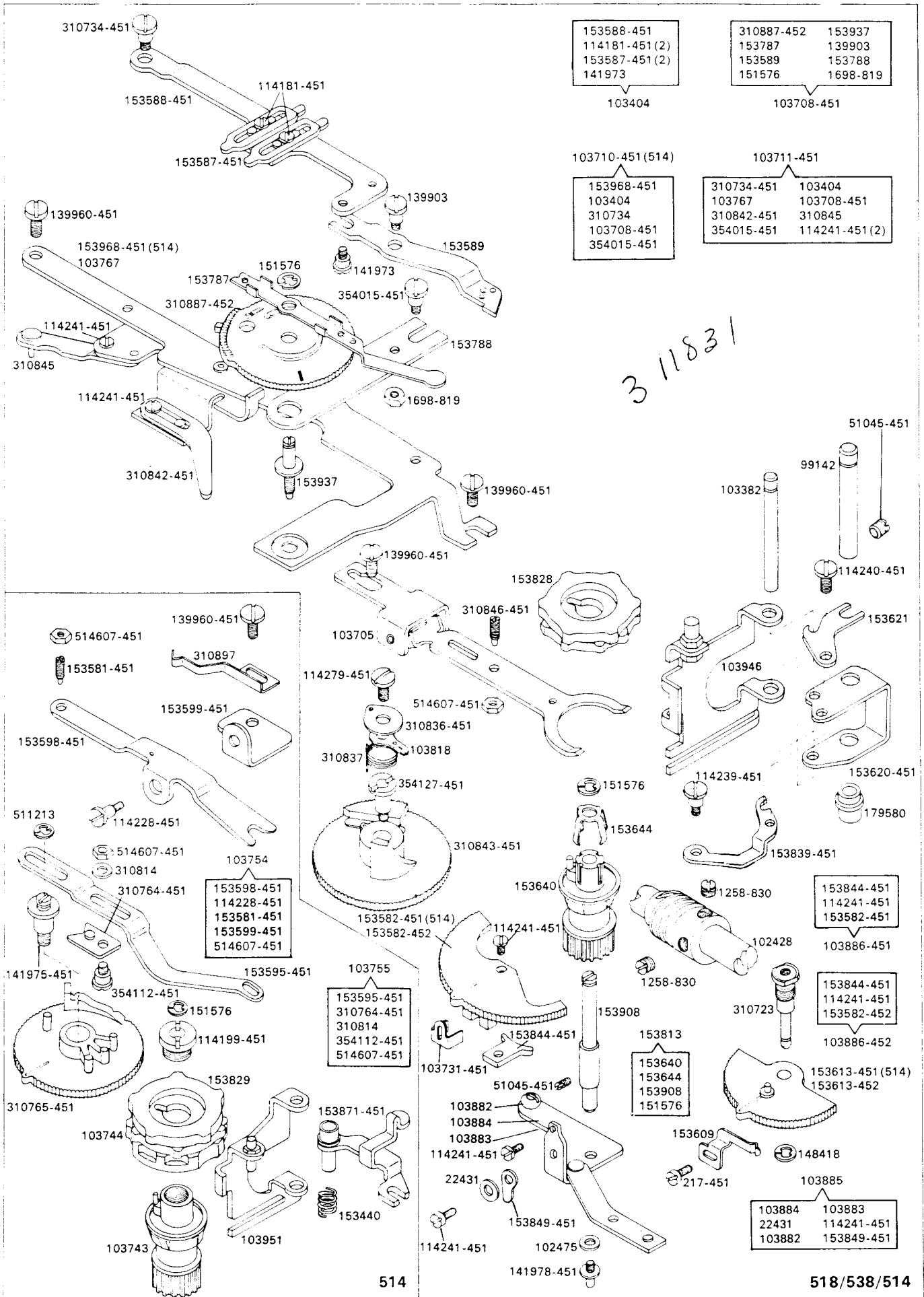

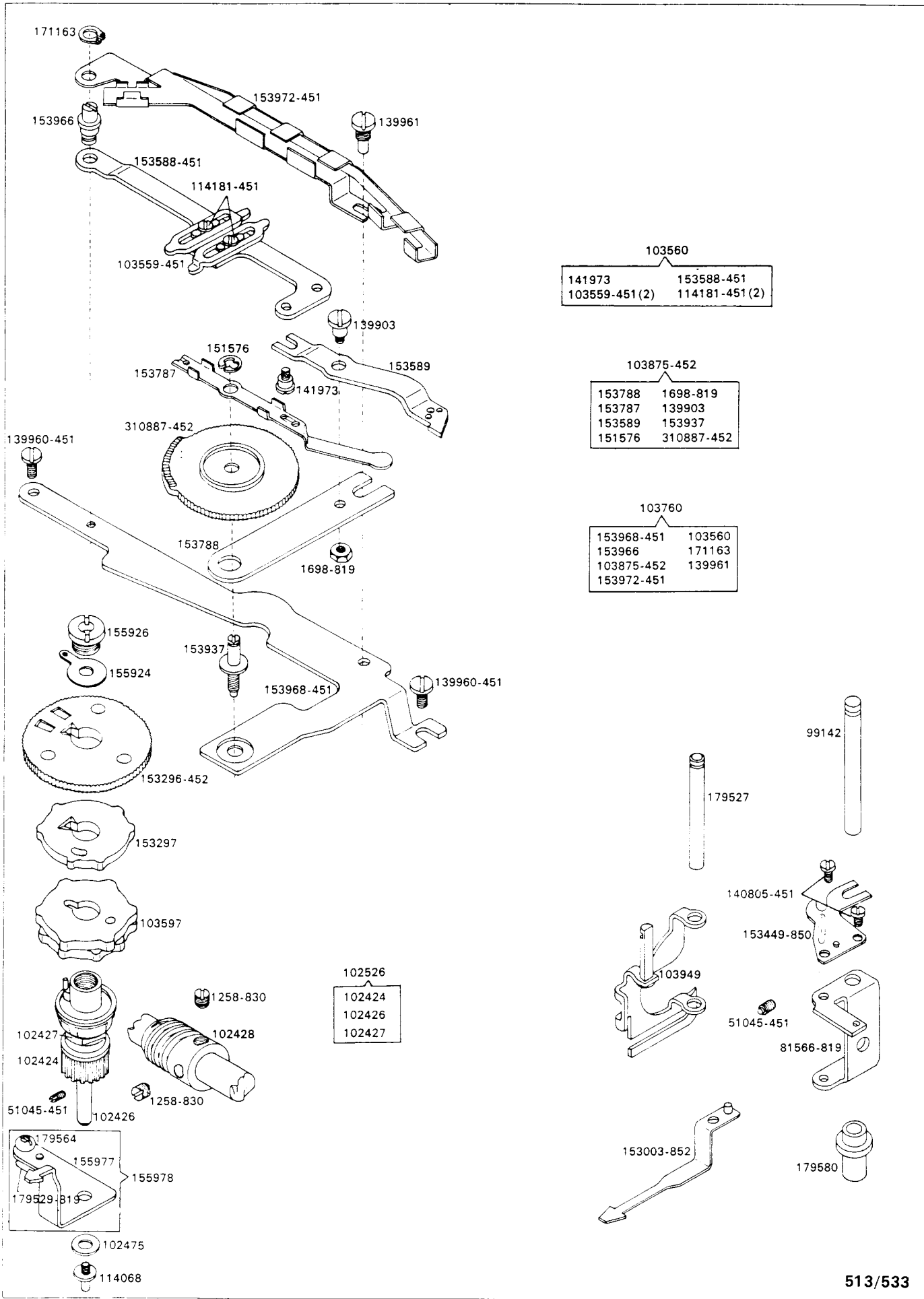

103560	
141973	153588-451
103559-451(2)	114181-451(2)

103875-452	
153788	1698-819
153787	139903
153589	153937
151576	310887-452

103760	
153968-451	103560
153966	171163
103875-452	139961
153972-451	

102526	
102424	
102426	
102427	

179564	
155977	
179529-819	

From the library of: Diamond Needle Corp

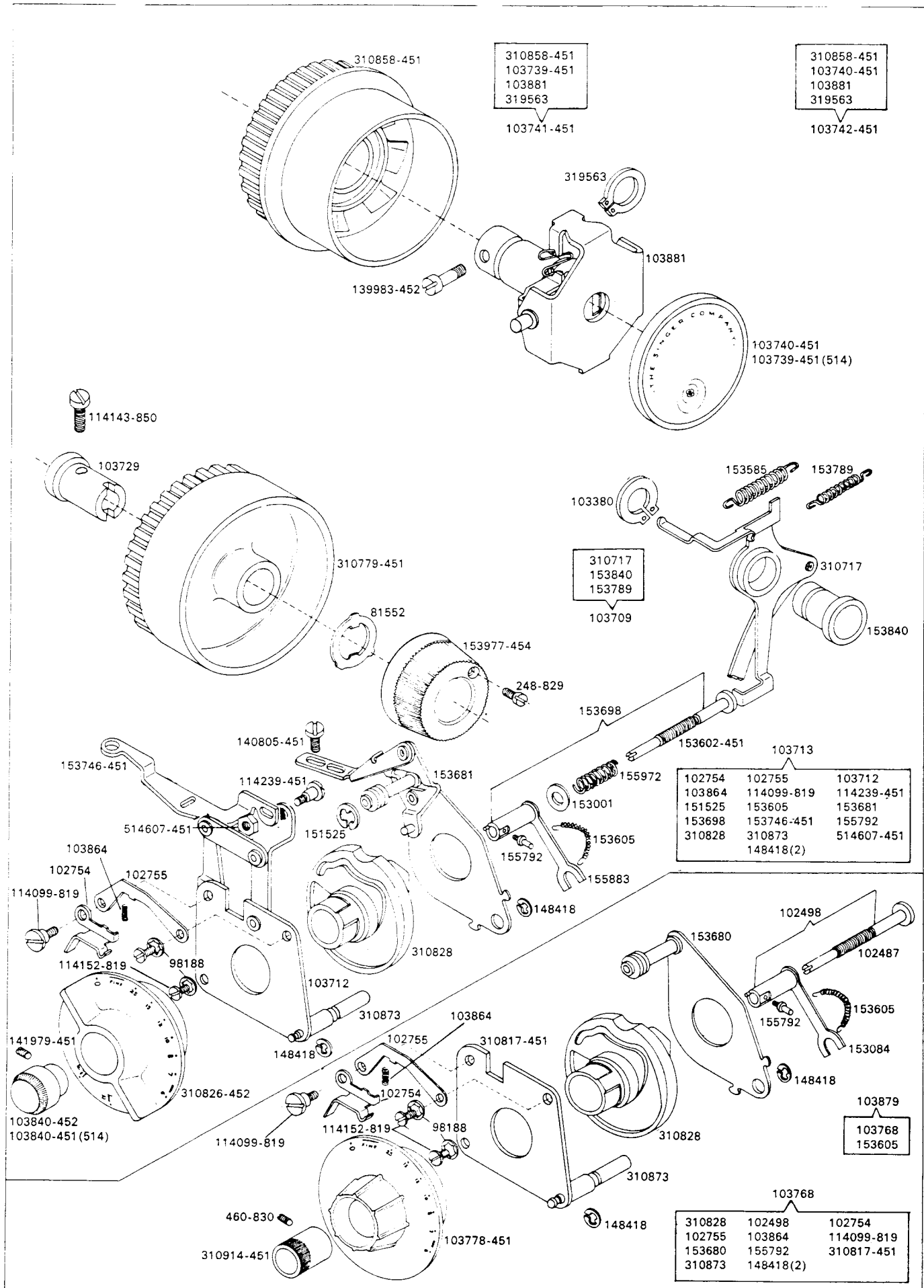

From the library of: Diamond Needle Corp

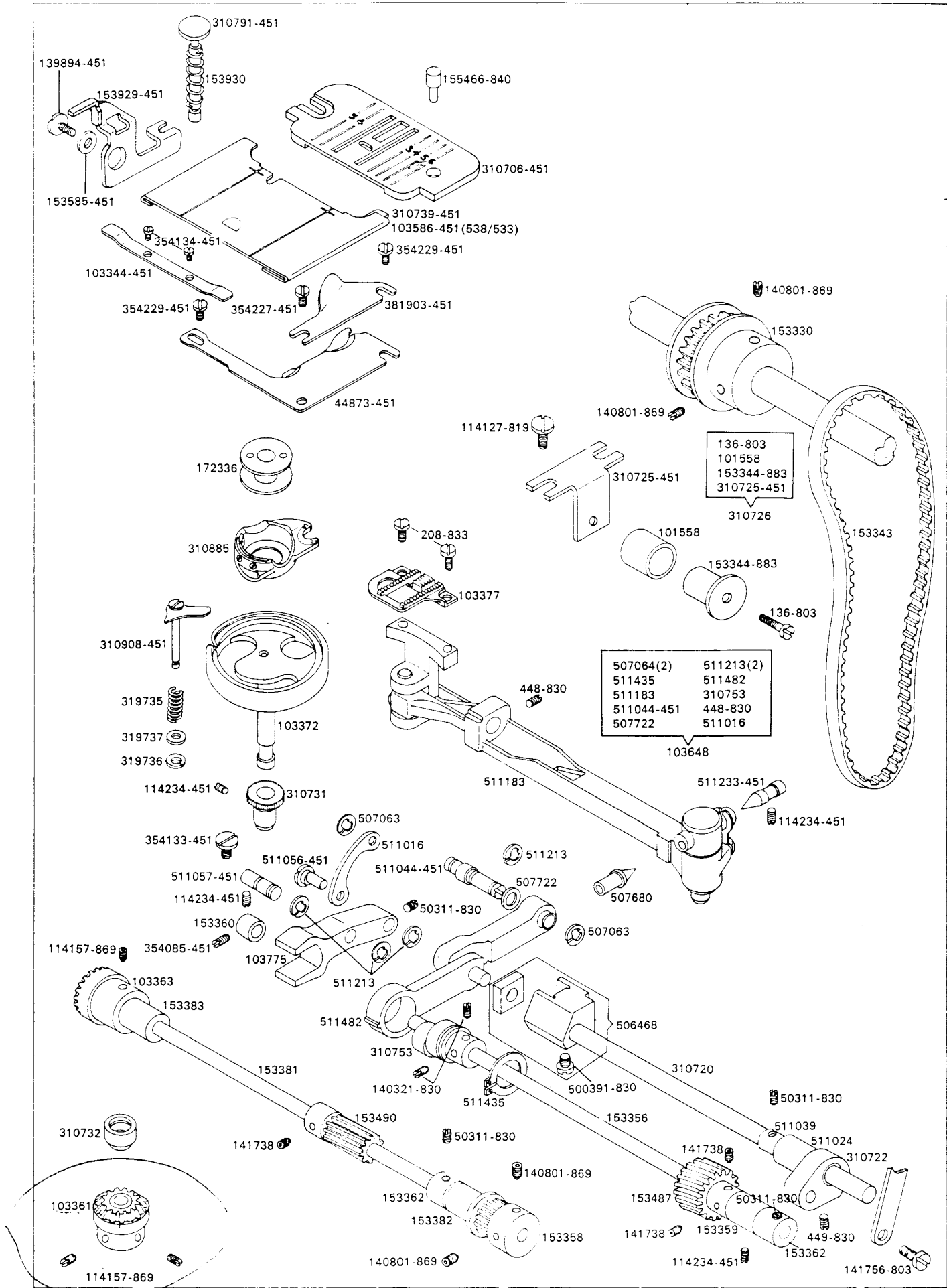

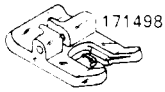

171498

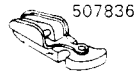

507836

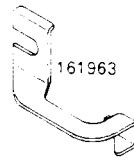

161963

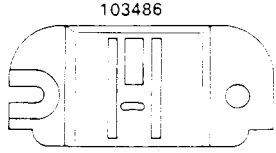

103486

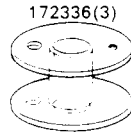

172336(3)

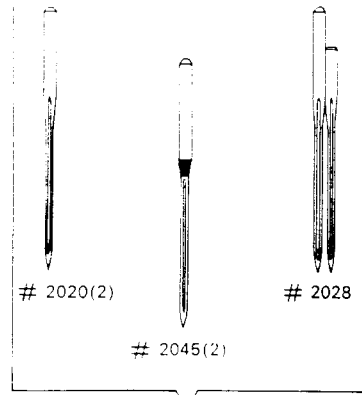

2020(2)

2045(2)

2028

513K/533K

103473

381087



276303

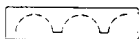

276304

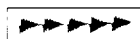

276305



276306

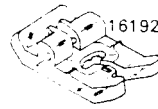

161927

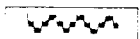

276312



276331



153267

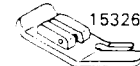

153267

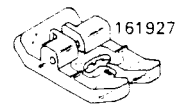

161927

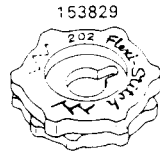

153829



153831

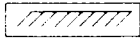

310920

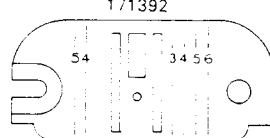

171392

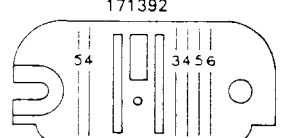

171392

518K/538K

514K

310901

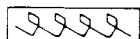

381085

381086



276307



276320



276308

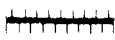

276321



276309



276322



276310



276323



276311



276324



276313



276325



276314



276326

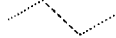

276315

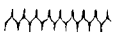

276327



276316



276328



276317



276329



276318



276330



276319

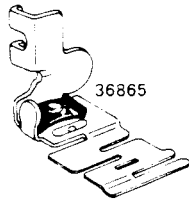

36865

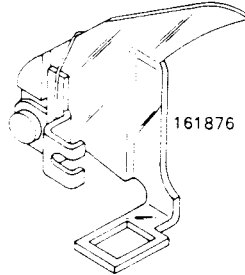

161876

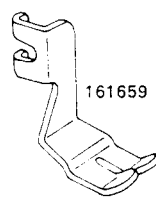

161659

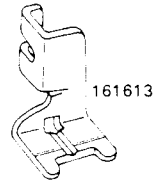

161613

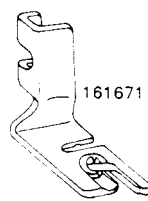

161671

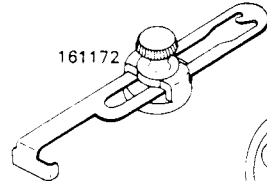

161172



161307

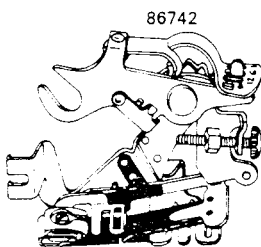

86742

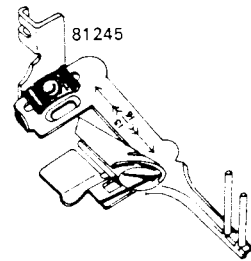

81245

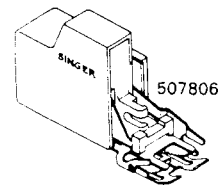

507806

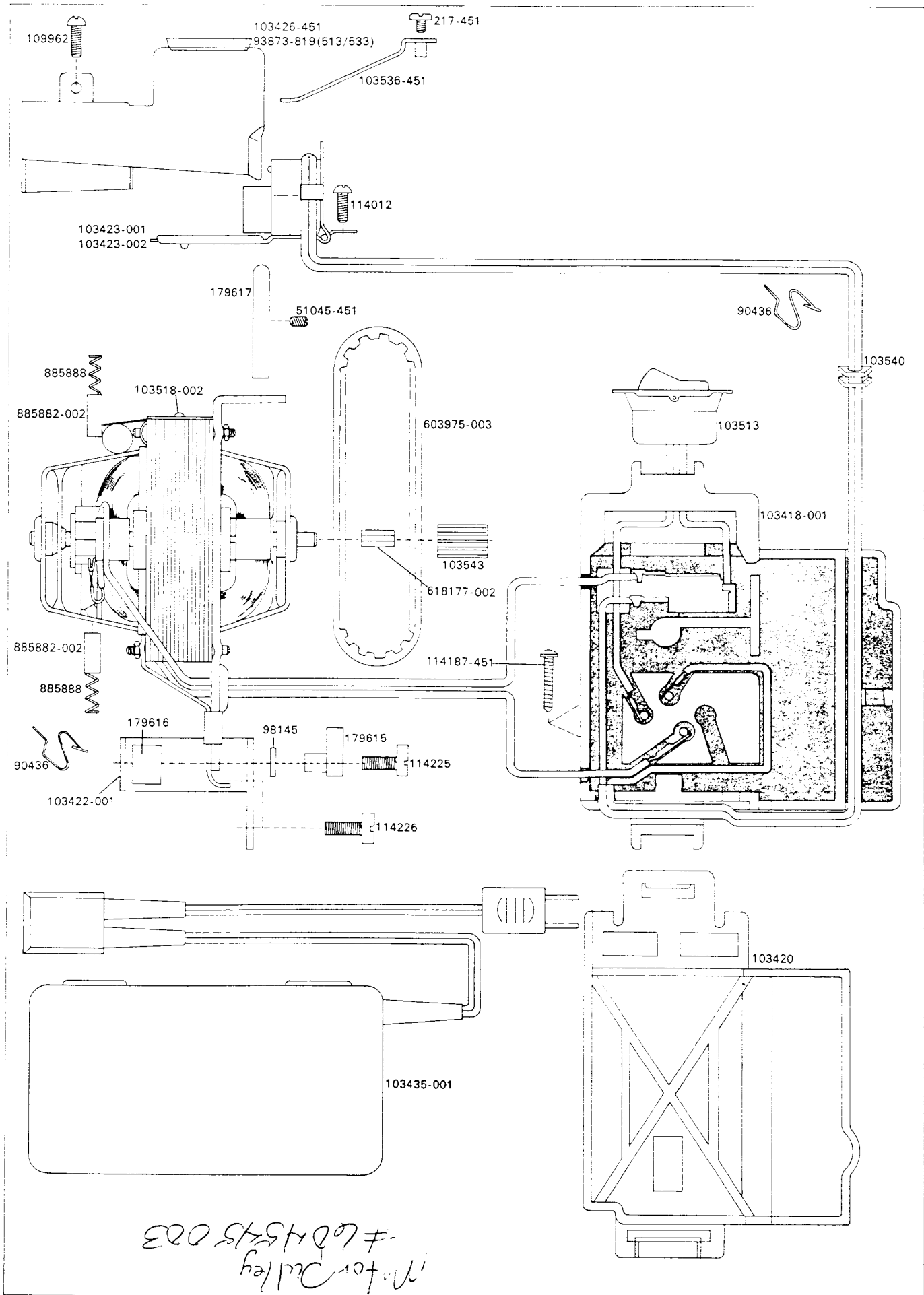

From the library of: Diamond Needle Corp

LIST OF PARTS

Part No.	Price	Description	Machine
85-805		Presser Bar Lifter Hinge Screw	518 538 514 513 533
136-803		Belt Tension Pulley Centre Screw	518 538 514 513 533
205-451		Bed Cover Plate (bottom) Retaining Screw (Finish—Spec. No. 1019)	518 514 513
208-833		Feed Dog Screw	518 538 514 513 533
217-451		Face Plate and Presser Bar Pressure Regulating Knob Bracket Holder Screw (Finish—Spec. No. 1019)	518 538 514
217-451		Light Retaining Clip Screw (Finish—Spec. No. 1019)	518 538 514 513 533
217-451		Needle Position Dial Position Spring Screw (Finish—Spec. No. 1019)	518 538 514
248-829		Clamp Stop Motion Clamp Stop Screw	513 533
448-830		Feed Bar Connection and Feed Lifting Fork Connection Hinge Stud (eccentric) Set Screw	518 538 514 513 533
449-830		Feed Regulator Shaft Crank Set Screw	518 538 514 513 533
453-832		Presser Bar Guide Bracket Set Screw	518 538 514 513 533
460-830		Feed Regulator Positioning Pin Knob Set Screw	513 533
853-858		Tension Indicator Flange Adaptor Thumb Nut Set Screw	513 533
1258-830		Arm Shaft (horizontal) Driving Worm Gear Set Screw	518 538 514 513 533
1258-830		Needle Bar Clamping Screw	518 538 514 513 533
1258-830		Thread Take-up Crank Set Screw	518 538 514 513 533
1698-819		Cam Controlled Feed Regulator Bracket Driving Arm Hinge Screw Nut	518 538 514 513 533
Cat. 2020		Needle (15x1) for Regular Sewing	518 538 514 513 533
Cat. 2028		Twin Needle	518 538 514 513 533
Cat. 2045		Yellow-Band Needle (15x1) for Sewing Synthetic Materials	518 538 514 513 533
8879-609		Arm Spool Pin Washer (packed with Attachments)	518 538 514 513 533

Part No.	Price	Description	Machine
8879-702		Bed Cover Plate (bottom) Screw Thumb Nut Washer	518 514 513
8879-702		Bed Cover Plate (bottom) Screw Washer	538 533
12329		Tension Releasing Lever Spring	513 533
22431		Bight Amplitude Control Dial Bracket Stop Screw Friction Washer (Finish—Spec. No. 1003)	518 538 514
23258-810		Needle Bar Stop and Thread Guide Screw Washer	518 538 514
33730-701		Bobbin Winder Friction Ring	518 538 514 513 533
36865		Edge Stitcher (supplied at an extra charge)	518 538 514 513 533
44873-451		Rotating Hook Bobbin Case Position Plate (Finish—Spec. No. 1054)	518 538 514 513 533
45847		Bobbin Winder Tension Disc Spring	518 538 514 513 533
45915-855		Bobbin Winder Tension Disc	518 538 514 513 533
50150-830		Needle Bar Rocker Collar Set Screw	518 538 514 513 533
50311-830		Feed Drive Shaft Collar Set Screw	518 538 514 513 533
50311-830		Feed Lifting Fork Connection Hinge Stud (eccentric) Set Screw	518 538 514 513 533
50311-830		Feed Regulator Shaft Collar Set Screw	518 538 514 513 533
50311-830		Rotating Hook Drive Shaft Collar Set Screw	518 538 514 513 533
50311-830		Thread Take-up Thread Guide Set Screw	518 538 514
50421-830		Tension Stud Set Screw	513 533
50429-830		Needle Bar Rocker Bracket Hinge Pin Set Screw	518 538 514 513 533
51045-451		Bight Amplitude Control Dial and Disc Driving Gear Shaft Set Screw (Finish—Spec. No. 1003)	518 538 514 513 533
51045-451		Machine Hinge Connection Set Screw (Finish—Spec. No. 1003)	518 514 513
51045-451		Motor Mounting Pin Set Screw (Finish—Spec. No. 1003)	518 538 514 513 533
51045-451		Needle Position Selector Hinge Pin Set Screw (Finish—Spec. No. 1003)	518 538 514 513 533

Part N	Price	Description	Machine
51045-451		Presser Bar Bushing Set Screw (Finish—Spec. No. 1003)	518 538 514 513 533
51361-833		Bed Cover Plate (bottom) Screw	518 514 513
66774-002		Thread Take-up Spring	513 533
81245		Binder (supplied at an extra charge)	518 538 514 513 533
81552		Clamp Stop Motion Clamp Washer	513 533
81566-819		Needle Position Selector Bracket	513 533
81572		Tension Releasing Pin	513 533
86742		Ruffler (supplied at an extra charge)	518 538 514 513 533
90374		Arm End Cover Plate Fixing Stud Retaining Clip	518 538 514 513 533
90436		Light Lead Clamping Clip	513 533
92980		Needle Bar Rocker Eccentric Hinge Stud	513 533
93873-819		Light Shield	513 533
96396		Arm Shaft (horizontal) Bushing (front) Retaining Pin	518 538 514 513 533
98145		Motor Insulating Bushing Support Washer	518 538 514 513 533
98188		Buttonholer Mechanism Mounting Plate Screw Washer	518 538 514 513 533
99071		Needle Bar Rocker Eccentric Hinge Stud	518 538 514
99142		Needle Position Selector Hinge Pin	518 538 514 513 533
101558		Belt Tension Pulley	518 538 514 513 533
102424		Disc Driving Gear	513 533
102426		Bight Amplitude Control Lever and Disc Driving Gear Shaft	513 533
102427		Disc Driving Gear Retaining Clip	513 533
102428		Arm Shaft (horizontal) Driving Worm Gear with two 1258-830	518 538 514 513 533
102475		Bight Amplitude Control Dial and Disc Driving Gear Shaft Screw Stud Friction Washer	518 538 514 513 533

From the library of: Diamond Needle Corp

Part No.	Price	Description	Machine
102487		Feed Regulator Positioning Pin	513 533
102498		Feed Regulator Positioning Pin Carrier 153084 with 102487	513 533
102522		Needle Bar	518 538 514 513 533
102523		Needle Bar Gib	518 538 514 513 533
102526		Disc Driving Gear 102424 with 102426 and 102427	513 533
102688		Needle Bar Connecting Link	518 538 514 513 533
102754		Buttonholer Mechanism Mounting Plate Pawl	518 538 514 513 533
102755		Buttonholer Mechanism Mounting Plate Pawl Spring Retainer	518 538 514 513 533
102810-821		Presser Bar	518 538 514 513 533
102940-006		Electrical Data Plate (110-120 volts)	518 538 514 513 533
103281		Presser Bar Spring	518 538 514 513 533
103283		Presser Bar Pressure Regulating Knob Follower Washer	513 533
103291		Needle Bar Connecting Stud	518 538 514 513 533
103308		Arm Shaft (horizontal) Bushing (front)	518 538 514 513 533
103310		Arm Shaft (horizontal) Collar with two 114024-830	518 538 514 513 533
103344-451		Bed Slide Spring (Finish—Spec. No. 1050)	518 538 514 513 533
103361		Rotating Hook Bevel Gear with two 114157-869	518 538 514 513 533
103363		Rotating Hook Drive Shaft Bevel Gear with 114157-869	518 538 514 513 533
103372		Rotating Hook	518 538 514 513 533
103377		Feed Dog	518 538 514 513 533
103380		Cam Controlled Feed Regulator Driving Bracket Retainer	518 538 514 513 533
103382		Bight Amplitude Bracket Hinge Pin	518 538 514
103404		Cam Controlled Feed Cam Follower Lever 153588-451 with 141973 and two each 114181-451 and 153587-451	518 538 514

Part No.	Price	Description	Machine
103418-001		Switch Module	518 538 514 513 533
103420		Switch Module Cover	518 538 514 513 533
103422-001		Motor Mounting Bracket	518 538 514 513 533
103423-001		Light with Lead	518 538 514 513 533
103423-002		Light with Lead	513 533
103426-451		Light Shield (Finish—Spec. No. 1076)	518 538 514
103432-451		Bed Grommet (Colour—Spec. No. 3152)	518 514 513
103435-001		Foot Controller (95-145 volts)	518 538 514 513 533
103473		5-Needle Pack containing one each Cat. 2020, sizes 11 and 16, one Cat. 2028, size 14, and two Cat. 2045, size 14	518 538 514 513 533
103486		Feed Cover Plate	518 538 514 513 533
103513		Switch	518 538 514 513 533
103518-002		ENK8-8 Motor	518 538 514 513 533
103536-451		Light Retaining Clip (Finish—Spec. No. 1116)	518 538 514 513 533
103540		Light Lead Grommet	513 533
103543		Motor Pinion	518 538 514 513 533
103559-451		Cam Controlled Feed Cam Follower (Finish—Spec. No. 1019)	513 533
103559-451		Cam Controlled Feed Cam Follower Stop (Finish—Spec. No. 1019)	513 533
103560		Cam Controlled Feed Cam Follower Lever 153588-451 with 141973 and two each 103559-451 and 114181-451	513 533
103585-451		Throat Plate Clamp Releasing Lever Hinge Screw Washer (Finish—Spec. No. 1019)	518 538 514 513 533
103586-451		Bed Slide (Finish—Spec. No. 1039)	538 533
103594		Bobbin Winder with 33730-701 and 173770-011	518 538 514 513 533
103597		Cam Controlled Feed and Bight Disc	513 533

Part No.	Price	Description	Machine
103618-451		Arm and Bed (Colour—Spec. No. 3151) with 93873-819, 96396, 103308, 109962, 153359, 153360, 153382, 153383, 153840, 354085-451, 511024 and two each 51045-451 and 114234-451	513
103621-451		Arm and Bed (Colour—Spec. No. 3151) with 93873-819, 96396, 103308, 109962, 153359, 153360, 153382, 153383, 153840, 354085-451, 511024 and two each 51045-451 and 114234-451	533
103640-451		Bed Leg (Colour—Spec. No. 3151)	538 533
103641-451		Bed Leg 103640-451 with 114236-451, 172203 and 507064	538 533
103648		Feed Bar 511183 with 448-830, 310753, 507722, 511016, 511044-451, 511213, 511435, 511482 and two 507064	518 538 514 513 533
103703-451		Arm Top Cover 153904-451 with 103594, 103912, 139893-452, 153772-451, 153803-451, 153867-452, 153868, 310763-451, 310778-451 and four 139893-451	514
103704-451		Arm Top Cover 153906-451 with 103594, 103912, 139893-452, 153731-452, 153772-451, 153803-451, 153867-452, 153868, 153933, 310763-451, 310778-451 and five 139893-451	518 538
103705		Disc Releasing Lever with 310846-451 and 514607-451	518 538
103708-451		Cam Controlled Feed Disengaging Lever 153788 with 1698-819, 139903, 151576, 153589, 153787, 153937 and 310887-452	518 538 514
103709		Cam Controlled Feed Regulator Driving Bracket 310717 with 153585 and 153789	518 538 514 513 533
103710-451		Cam Controlled Feed Modular Mounting Plate 153968-451 with 103404, 103708-451, 310734 and 354015-451	514
103711-451		Cam Controlled Feed Modular Mounting Plate 103767 with 103404, 103708-451, 310734-451, 310842-451, 310845, 354015-451 and two 114241-451	518 538
103712		Buttonholer Mechanism Mounting Plate	518 538 514
103713		Buttonholer and Feed Regulator Mechanism, complete, Nos. 102754, 102755, 103712, 103864, 114099-819, 114239-451, 151525, 153605, 153681, 153698, 153746-451, 155792, 310828, 310873, 514607-451 and two 148418	518 538 514
103715		Bed Cover Plate (bottom)	538 533
103729		Clamp Stop Motion Flanged Bushing	513 533
103731-451		Bight Amplitude Control Dial Bridge Washer (Finish—Spec. No. 1050)	518 538 514

Part No	Price	Description	Machine
103739-451		Hand Wheel Nameplate	514
103740-451		Hand Wheel Nameplate	518 538
103741-451		Hand Wheel 310858-451 with 103739-451, 103881 and 319563	514
103742-451		Hand Wheel 310858-451 with 103740-451, 103881 and 319563	518 538
103743		Disc Driving Gear	514
103744		Double Cam	514
103754		Disc Selector Rocker Arm 153598-451 with 114228-451, 153581-451, 153599-451 and 514607-451	514
103755		Disc Follower Disengaging Lever 153595-451 with 310764-451, 310814, 354112-451 and 514607-451	514
103758-451		Arm and Bed (Colour—Spec. No. 3151) with 96396, 103308, 153359, 153360, 153382, 153383, 153840, 354085-451, 511024 and two each 51045-451 and 114234-451	518 514
103760		Cam Controlled Feed Modular Mounting Plate 153968-451 with 103560, 103875-452, 139961, 153966, 153972-451 and 171163	513 533
103761		Control Panel Fastener	518 538 514 513 533
103762-006		Arm End Cover Plate 153528-451 with 102940-006 (110-120 volts)	518 538 514
103763-006		Arm End Cover Plate 310808-451 with 102940-006 (110-120 volts)	513 533
103764-451		Tension Releasing Lever Hinge Screw Adjusting Washer (Finish—Spec. No. 1019)	518 538 514
103767		Cam Controlled Feed Modular Mounting Plate	518 538
103768		Feed Regulator Cam 310828 with 102498, 102754, 102755, 103864, 114099-819, 153680, 155792, 310817-451, 310873 and two 148418	513 533
103775		Feed Lifting Fork with 50311-830, 511057-451 and two 511213	518 538 514 513 533
103778-451		Feed Regulator Control Dial (Colour—Spec. No. 3319)	513 533
103818		Disc Releasing Dial Detent Spring	518 538

Part No.	Price	Description	Machine
103840-451		Feed Regulator Positioning Pin Knob (Colour—Spec. No. 3319) with 141979-451	514
103840-452		Feed Regulator Positioning Pin Knob (Colour—Spec. No. 3319) with 141979-451	518 538
103847-451		Arm Top Cover 310902-452 with 103594, 103912, 139893-452, 153772-451, 153867-452, 153868, 153888-453 and two 139893-451	513 533
103862		Bed Cover Plate Adaptor	518 514 513
103864		Buttonholer Mechanism Mounting Plate Pawl Spring	518 538 514 513 533
103873-451		Guard Plate (Finish—Spec. No. 1019)	518 538 514
103874-451		Arm End Cover Plate Fixing Stud (Finish—Spec. No. 1021)	518 538 514 513 533
103875-452		Cam Controlled Feed Disengaging Lever 153788 with 1698-819, 139903, 151576, 153589, 153787, 153937 and 310887-452	513 533
103879		Feed Regulator Mechanism 103768 with 153605	513 533
103881		Hand Wheel Disengaging Clutch Mechanism	518 538 514
103882		Needle Bar Rocker Driving Arm Position Stud	518 538 514
103883		Bight Amplitude Control Dial Bracket Clamping Plate	518 538 514
103884		Bight Amplitude Control Dial Bracket	518 538 514
103885		Bight Amplitude Control Dial Bracket 103884 with 22431, 103882, 103883, 114241-451 and two 153849-451	518 538 514
103886-451		Bight Amplitude Control Dial 153582-451 with 114241-451 and 153844-451	514
103886-452		Bight Amplitude Control Dial 153582-452 with 114241-451 and 153844-451	518 538
103888-452		Face Plate (Colour—Spec. No. 3152)	513 533
103912		Bobbin Winder Actuating Dial Backing Plate Retaining Ring	518 538 514 513 533
103940		Presser Bar Pressure Regulating Knob Follower Pin 153737-451 with 153843	518 538 514
103946		Bight Amplitude Bracket	518 538
103949		Bight Amplitude Bracket	513 533

Part No.	Price	Description	Machine
103951		Bight Amplitude Bracket	514
103967		Bed Cover Plate (bottom) Blanking Disc	518 514 513
109828-803		Tension Releasing Lever Hinge Screw	513 533
109962		Guard Plate Screw	518 538 514
109962		Light Shield Screw	518 538 514 513 533
113170-833		Bed Cover Plate (bottom) Screw Thumb Nut	518 514 513
114012		Light Fixing Screw	518 538 514 513 533
114019-832		Needle Bar Stop and Thread Guide Screw	518 538 514
114024-830		Arm Shaft (horizontal) Collar Set Screw	518 538 514 513 533
114061-851		Arm Top Cover Screw (left)	518 538 514 513 533
114068		Bight Amplitude Control Lever Spring Screw Stud	513 533
114099-819		Buttonholer Mechanism Mounting Plate Pawl Spring Retainer Screw	518 538 514 513 533
114115-819		Presser Bar Pressure Regulating Knob Bracket Screw	513 533
114127-819		Belt Tension Adjuster Bracket Screw	518 538 514 513 533
114139-851		Arm End Cover Plate Screw	518 538 514 513 533
114143-850		Clamp Stop Motion Flanged Bushing Set Screw	513 533
114147-451		Needle Bar Rocker Driving Arm Follower Screw (Finish—Spec. No. 1005)	518 538 514 513 533
114152-819		Buttonholer Mechanism Mounting Plate Screw	518 538 514
114152-819		Face Plate and Presser Bar Pressure Regulating Knob Bracket Screw	518 538 514
114152-819		Feed Regulator Mechanism Mounting Screw	513 533
114152-819		Thread Wear Bar Screw	518 538 514
114152-850		Arm Side Cover Screw	513 533
114157-869		Rotating Hook Bevel Gear Set Screw	518 538 514 513 533

Part No.	Price	Description	Machine
114157-869		Rotating Hook Drive Shaft Bevel Gear Set Screw	518 538 514 513 533
114181-451		Cam Controlled Feed Cam Follower and Stop Screw (Finish—Spec. No. 1030)	518 538 514 513 533
114186-451		Thread Take-up Lever Link Hinge Stud Set Screw (Finish—Spec. No. 1003)	513 533
114187-451		Switch Module Mounting Screw (Finish—Spec. No. 1076)	518 538 514 513 533
114199-451		Disc Clamping Screw (Finish—Spec. No. 1019)	514
114225		Motor Mounting Screw	518 538 514 513 533
114226		Motor Mounting Bracket Screw	518 538 514 513 533
114228-451		Disc Selector Rocker Arm Hinge Screw (Finish—Spec. No. 1003)	514
114230-451		Bed Leg Screw (Finish—Spec. No. 1019)	538 533
114233-451		Bed Cover Plate (tubular) Screw (Finish—Spec. No. 1019)	538 533
114234-451		Feed Bar Guide Pin (eccentric) Centre (back) Set Screw (Finish—Spec. No. 1003)	518 538 514 513 533
114234-451		Feed Drive Shaft Bushing (back) Set Screw (Finish— Spec. No. 1003)	518 538 514 513 533
114234-451		Feed Lifting Fork Hinge Stud Set Screw (Finish—Spec. No. 1003)	518 538 514 513 533
114234-451		Rotating Hook Flanged Bushing (eccentric) Set Screw (Finish—Spec. No. 1003)	518 538 514 513 533
114235-451		Bed Extension Locking Lever Pivot Screw (Finish— Spec. No. 1019)	538 533
114236-451		Bed Cushion Screw (Finish—Spec. No. 1005)	538 533
114236-451		Bed Leg Cushion Screw (Finish—Spec. No. 1005)	538 533
114239-451		Buttonholer Needle Position Dial Connecting Link Hinge Screw (Finish—Spec. No. 1050)	518 538 514
114239-451		Needle Position Dial Connecting Link Hinge Screw (Finish—Spec. No. 1050)	518 538 514
114240-451		Needle Position Selector Bracket and Bight Amplitude Bracket Retainer Screw (Finish—Spec. No. 1050)	518 538 514

Part No.	Price	Description	Machine	
114240-451		Presser Bar Pressure Regulating Knob Follower Pin Adjusting Collar Screw (Finish—Spec. No. 1050)	518 538	514
114240-451		Tension Releasing Pin Collar Set Screw (Finish—Spec. No. 1050)	518 538	514
114241-451		Right Amplitude Control Dial Bracket Stop Screw (Finish—Spec. No. 1019)	518 538	514
114241-451		Right Amplitude Control Dial Mounting Screw (Finish—Spec. No. 1019)	518 538	514
114241-451		Right Amplitude Control Dial Stabiliser Screw (Finish—Spec. No. 1019)	518 538	514
114241-451		Disc Release Disengaging Lever Screw (Finish—Spec. No. 1019)	518 538	
114241-451		Disc Release Disengaging Lever Bracket Screw (Finish—Spec. No. 1019)	518 538	
114254-451		Bed End Cover Plate and Switch Module Mounting Screw (Finish—Spec. No. 1021)	538	533
114257-451		Bed Cover Plate (bottom) Screw (Finish—Spec. No. 1019)	538	533
114279-451		Disc Releasing Lever Guide Stud (Finish—Spec. No. 1003)	518 538	
114281-451		Needle Bar Rocker Driving Arm Clamping Screw (Finish—Spec. No. 1003)	518 538 514	513 533
125314		Tension Spring		513 533
139890-451		Thread Take-up Lever Link Hinge Stud Set Screw (Finish—Spec. No. 1003)	518 538	514
139893-451		Arm Top Cover Lid Spring Screw (Finish—Spec. No. 1019)	518 538	
139893-451		Bobbin Winder Mounting Screw (Finish—Spec. No. 1019)	518 538 514	513 533
139893-451		Tension Mounting Plate Screw (Finish—Spec. No. 1019)	518 538	514
139893-452		Bobbin Winder Stop Screw (Finish—Spec. No. 1052)	518 538 514	513 533
139894-451		Tension Releasing Lever Hinge Screw (Finish—Spec. No. 1019)	518 538	514
139894-451		Throat Plate Clamp Releasing Lever Hinge Screw (Finish—Spec. No. 1019)	518 538 514	513 533

Part No.	Price	Description	Machine
139903		Cam Controlled Feed Regulator Bracket Driving Arm Hinge Screw	518 538 514 513 533
139958-451		Arm Top Cover Screw (right) (Finish—Spec. No. 1051)	518 538 514 513 533
139960-451		Cam Controlled Feed Modular Mounting Plate Screw (Finish—Spec. No. 1019)	518 538 514 513 533
139960-451		Disc Releasing Lever Bracket Screw (Finish—Spec. No. 1019)	518 538
139960-451		Disc Selector Rocker Arm Mounting Bracket Screw (Finish—Spec. No. 1019)	514
139961		Cam Controlled Feed Disengaging Lever Guide Screw	513 533
139983-452		Hand Wheel Disengaging Clutch Bushing Screw (Finish—Spec. No. 1005)	518 538 514
140295-852		Face Plate Screw	518 538 514 513 533
140321-830		Feed Lifting Cam and Feed Eccentric Set Screw	518 538 514 513 533
140321-830		Needle Bar Rocker Eccentric Hinge Stud Set Screw	518 538 514 513 533
140751-851		Needle Thumb Screw	518 538 514 513 533
140801-869		Arm Shaft (horizontal) Belt Drive Pulley Set Screw	518 538 514 513 533
140801-869		Rotating Hook Drive Shaft Belt Pulley Set Screw	518 538 514 513 533
140805-451		Buttonholer Bight Control Cam Follower Lever Link Screw (Finish—Spec. No. 1003)	518 538 514
140805-451		Needle Position Selector Lever Screw (Finish—Spec. No. 1003)	513 533
140805-451		Needle Position Selector Lever Spring Screw (Finish—Spec. No. 1003)	513 533
140912-852		Slack Thread Regulator and Tension Thread Guide Screw	513 533
141031-855		Needle Clamp and Needle Stop Screw	518 538 514 513 533
141142-805		Presser Bar Pressure Regulating Knob Screw	518 538 514 513 533
141738		Feed Drive Shaft Gear Set Screw	518 538 514 513 533
141738		Rotating Hook Drive Shaft Gear Set Screw	518 538 514 513 533
141756-803		Feed Regulator Shaft Crank Hinge Screw	518 538 514 513 533

Part No.	Price	Description	Machine
141959		Arm Top Cover Mounting Bracket Screw (Finish—Spec. No. 1019)	518 538 514 513 533
141973		Cam Controlled Feed Cam Follower Lever Driving Hinge Screw	518 538 514 513 533
141975-451		Disc Selector Dial and Disc Follower Disengaging Lever Hinge Screw (Finish—Spec. No. 1050)	514
141978-451		Bight Amplitude Control Dial and Disc Driving Gear Shaft Screw Stud (Finish—Spec. No. 1114)	518 538 514
141979-451		Feed Regulator Positioning Pin Knob Set Screw (Finish—Spec. No. 1019)	518 538 514
148418		Buttonholer and Feed Regulator Cam Mounting Bracket Retainer	518 538 514 513 533
148418		Buttonholer Mechanism Mounting Plate Retainer	518 538 514 513 533
148418		Needle Position Dial Retainer	518 538 514
151525		Buttonholer Needle Position Cam Follower Lever Retainer	518 538 514
151576		Cam Controlled Feed Dial Position Spring Retainer	518 538 514 513 533
151576		Disc Driving Gear Retainer	514
151576		Disc Retaining Spring Retainer	518 538
153001		Feed Regulator Positioning Pin Friction Spring Washer	518 538 514
153003-852		Needle Position Selector Lever	513 533
153084		Feed Regulator Positioning Pin Carrier	513 533
153267		Straight Stitch Foot	518 538 514
153276		Tension Indicator Flange Adaptor Thumb Nut with 853-858	513 533
153277-453		Tension Indicator Flange 173670-453 with 153276 and 172215-856	513 533
153278-453		Tension, complete, Nos. 66774-002, 81572, 125314, 153277-453, 153318-856, 172218, 172228-856, 173669-453 and three 172226	513 533
153296-452		Blindstitch Disc and Actuating Dial (Colour—Spec. No. 3152)	513 533

Part No.	Price	Description	Machine
153297		Blindstitch Disc	513 533
153318-856		Tension Stud	513 533
153330		Arm Shaft (horizontal) Belt Drive Pulley with two 140801-869	518 538 514 513 533
153334-451		Bed Cover Plate (tubular) (Colour—Spec. No. 3152)	538 533
153343		Belt	518 538 514 513 533
153344-883		Belt Tension Pulley Centre	518 538 514 513 533
153356		Feed Drive Shaft	518 538 514 513 533
153358		Rotating Hook Drive Shaft Belt Pulley with two 140801-869	518 538 514 513 533
153359		Feed Drive Shaft Bushing (back)	518 538 514 513 533
153360		Feed Drive Shaft Bushing (front)	518 538 514 513 533
153362		Feed Drive Shaft Collar with 50311-830	518 538 514 513 533
153362		Rotating Hook Drive Shaft Collar with 50311-830	518 538 514 513 533
153381		Rotating Hook Drive Shaft	518 538 514 513 533
153382		Rotating Hook Drive Shaft Bushing (back)	518 538 514 513 533
153383		Rotating Hook Drive Shaft Bushing (front)	518 538 514 513 533
153414-452		Arm Side Cover (Colour—Spec. No. 3151)	513 533
153440		Disc Follower Spring	514
153449-850		Needle Position Selector Lever Spring	513 533
153487		Feed Drive Shaft Gear with two 141738	518 538 514 513 533
153490		Rotating Hook Drive Shaft Gear with two 141738	518 538 514 513 533
153519-451		Bed Extension Locking Lever Release Plunger (Colour—Spec. No. 3152)	538 533
153528-451		Arm End Cover Plate (Colour—Spec. No. 3151)	518 538 514
153533-451		Arm Top Cover Mounting Bracket (Finish—Spec. No. 1019)	518 538 514 513 533

Part No.	Price	Description	Machine
153559-451		Tension Releasing Lever (Finish—Spec. No. 1050)	518 538 514
153560-451		Tension Releasing Pin (Finish—Spec. No. 1003)	518 538 514
153564-451		Tension Stud Assembly (Colour—Spec. No. 3152)	518 538 514
153581-451		Disc Selector Rocker Arm Follower Screw (Finish—Spec. No. 1050)	514
153582-451		Bight Amplitude Control Dial (Colour—Spec. No. 3152)	514
153582-452		Bight Amplitude Control Dial (Colour—Spec. No. 3152)	518 538
153585		Cam Controlled Feed Regulator Driving Bracket and Driving Arm Spring	518 538 514 513 533
153587-451		Cam Controlled Feed Cam Follower (Finish—Spec. No. 1019)	518 538 514
153587-451		Cam Controlled Feed Cam Follower Stop (Finish—Spec. No. 1019)	518 538 514
153588-451		Cam Controlled Feed Cam Follower Lever (Finish—Spec. No. 1019)	518 538 514 513 533
153589		Cam Controlled Feed Regulator Bracket Driving Arm	518 538 514 513 533
153595-451		Disc Follower Disengaging Lever (Finish—Spec. No. 1019)	514
153598-451		Disc Selector Rocker Arm (Finish—Spec. No. 1019)	514
153599-451		Disc Selector Rocker Arm Mounting Bracket (Finish—Spec. No. 1019)	514
153602-451		Feed Regulator Positioning Pin (Finish—Spec. No. 1019)	518 538 514
153605		Feed Regulator Positioning Pin Knob Spring	518 538 514 513 533
153609		Needle Position Dial Position Spring	518 538 514
153613-451		Needle Position Dial (Colour—Spec. No. 3153)	514
153613-452		Needle Position Dial (Colour—Spec. No. 3154)	518 538
153620-451		Needle Position Selector Bracket (Finish—Spec. No. 1019)	518 538 514
153621		Needle Position Selector Bracket and Bight Amplitude Bracket Retainer	518 538 514

Part No.	Price	Description	Machine
153640		Disc Driving Gear	518 538
153644		Disc Retaining Spring	518 538
153652-451		Face Plate and Presser Bar Pressure Regulating Knob Bracket Holder (Finish—Spec. No. 1019)	518 538 514
153653-451		Face Plate and Presser Bar Pressure Regulating Knob Bracket (Finish—Spec. No. 1019)	518 538 514
153661		Presser Bar Guide Bracket with 453-832	518 538 514
153663		Tension Releasing Pin Collar with 114240-451	518 538 514
153666-451		Presser Bar Pressure Regulating Knob (Colour—Spec. No. 3152)	518 538 514
153680		Feed Regulator Cam Mounting Bracket	513 533
153681		Buttonholer and Feed Regulator Cam Mounting Bracket	518 538 514
153693-451		Face Plate (Colour—Spec. No. 3152)	518 538 514
153698		Feed Regulator Positioning Pin Carrier 155883 with 153001, 153602-451 and 155972	518 538 514
153712		Thread Take-up Lever	518 538 514 513 533
153713		Thread Take-up Lever 153712 with 102688	518 538 514 513 533
153731-452		Arm Top Cover Lid (Colour—Spec. No. 3152)	518 538
153737-451		Presser Bar Pressure Regulating Knob Follower Pin (Finish—Spec. No. 1003)	518 538 514
153739-451		Tension Cap and Slack Thread Regulator Nut Decal (Colour—Spec. No. 3153)	514
153739-452		Tension Cap and Slack Thread Regulator Nut Decal (Colour—Spec. No. 3154)	518 538
153746-451		Needle Position Dial Connecting Link (Finish—Spec. No. 1019)	518 538 514
153771		Bobbin Winder Spring	518 538 514 513 533
153772-451		Bobbin Winder Stop (Finish—Spec. No. 1053)	518 538 514 513 533
153787		Cam Controlled Feed Dial Position Spring	518 538 514 513 533
153788		Cam Controlled Feed Disengaging Lever	518 538 514 513 533

Part No.	Price	Description	Machine
153789		Cam Controlled Feed Regulator Driving Bracket Arm Spring	518 538 514 513 533
153802-451		Presser Bar Pressure Regulating Knob 153666-451 with 217-451, 141142-805 and 153653-451	518 538 514
153803-451		Tension, complete, Nos. 103764-451, 139894-451, 153559-451, 153564-451, 153873 and 354085-451	518 538 514
153809-451		Arm and Bed (Colour—Spec. No. 3151) with 96396, 103308, 153359, 153360, 153382, 153383, 153840, 354085-451, 511024 and two each 51045-451 and 114234-451	538
153813		Disc Driving Gear 153640 with 153644, 153908 and 151576	518 538
153828		Disc No. 201	518 538
153829		Disc No. 202	518 538 514
153831		Disc No. 232	518 538
153839-451		Needle Position Selector Bracket Adjusting Lever (Finish—Spec. No. 1019)	518 538 514
153840		Arm Shaft (horizontal) Bushing (back)	518 538 514 513 533
153843		Presser Bar Pressure Regulating Knob Follower Pin Adjusting Collar with 114240-451	518 538 514
153844-451		Bight Amplitude Control Dial Stabiliser (Finish—Spec. No. 1019)	518 538 514
153849-451		Bight Amplitude Control Dial Bracket Stop (Finish—Spec. No. 1019)	518 538 514
153865-453		Arm Top Cover Thread Guide and Bobbin Winder Tension Bracket Support (Colour—Spec. No. 3152)	513 533
153866-452		Arm Top Cover Thread Guide and Bobbin Winder Tension Bracket Screw Stud (Finish—Spec. No. 1029)	513 533
153867-452		Bobbin Winder Actuating Dial (Colour—Spec. No. 3152)	518 538 514 513 533
153868		Bobbin Winder Actuating Dial Backing Plate	518 538 514 513 533
153871-451		Disc Follower (Finish—Spec. No. 1087)	514
153873		Tension Disc Pressure Pin Spring Clip	518 538 514
153875-451		Control Panel (Colour—Spec. No. 3319) with 153652-451, 155805 and three 103761	514

Part No.	Price	Description	Machine
153879-451		Control Panel (Colour—Spec. No. 3319) with 153652-451, 155805 and three 103761	518
153881-451		Control Panel (Colour—Spec. No. 3319) with 153652-451, 155805 and three 103761	538
153888-453		Arm Top Cover Thread Guide and Bobbin Winder Tension Bracket, complete, Nos. 45847, 45915-855, 153865-453, 153866-452, 153947-451 and 172673	513 533
153904-451		Arm Top Cover (Colour—Spec. No. 3152)	514
153906-451		Arm Top Cover (Colour—Spec. No. 3152)	518 538
153908		Bight Amplitude Control Dial and Disc Driving Gear Shaft	518 538 514
153910-451		Thread Wear Bar (Finish—Spec. No. 1055)	518 538 514
153911-451		Thread Take-up Thread Guide (Finish—Spec. No. 1053)	518 538 514
153914-454		Presser Bar Pressure Regulating Knob 155899-453 with 141142-805 and 153970-451	513 533
153924		Arm Top Cover Mounting Bracket Locating Pin	518 538 514 513 533
153929-451		Throat Plate Clamp Releasing Lever (Finish—Spec. No. 1050)	518 538 514 513 533
153930		Throat Plate Clamp Spring	518 538 514 513 533
153933		Arm Top Cover Lid Spring	518 538
153937		Cam Controlled Feed Dial Shaft	518 538 514 513 533
153947-451		Arm Top Cover Thread Guide and Bobbin Winder Tension Bracket (Finish—Spec. No. 1055)	513 533
153966		Cam Controlled Feed Cam Follower Lever Hinge Screw Stud	513 533
153968-451		Cam Controlled Feed Modular Mounting Plate (Finish—Spec. No. 1019)	514 513 533
153969		Presser Bar Pressure Regulating Knob Follower	513 533
153970-451		Presser Bar Pressure Regulating Knob Bracket (Finish—Spec. No. 1019)	513 533
153972-451		Light Lead Control Bridge (Finish—Spec. No. 1019)	513 533
153977-454		Clamp Stop Motion Clamp Screw (Colour—Spec. No. 3152)	513 533

Part No.	Price	Description	Machine
155466-840		Throat Plate Position Pin	518 538 514 513 533
155727-821		Tension Thread Guide	513 533
155792		Reverse Feed Cam Follower	518 538 514 513 533
155805		Control Panel Fastener	518 538 514 513 533
155883		Feed Regulator Positioning Pin Carrier	518 538 514
155899-453		Presser Bar Pressure Regulating Knob (Colour—Spec. No. 3152)	513 533
155924		Blindstitch Disc Detent Spring	513 533
155926		Disc Retaining Screw Stud	513 533
155962-851		Presser Foot Plate	518 538 514 513 533
155964-851		Presser Foot Shank	518 538 514 513 533
155968		Needle Bar Rocker Driving Arm with 114147-451, 114281-451, 179566 and 310757	518 538 514 513 533
155972		Feed Regulator Positioning Pin Friction Spring	518 538 514
155977		Bight Amplitude Control Lever	513 533
155978		Bight Amplitude Control Lever 155977 with 179529-819 and 179564	513 533
161172		Seam Guide (supplied at an extra charge)	518 538 514 513 533
161307		Needle Threader (supplied at an extra charge)	518 538 514 513 533
161613		Button Foot (supplied at an extra charge)	518 538 514 513 533
161659		Gathering Foot (supplied at an extra charge)	518 538 514 513 533
161671		Hemmer Foot (supplied at an extra charge)	518 538 514 513 533
161876		Darning and Embroidery Foot (supplied at an extra charge)	518 538 514 513 533
161927		Buttonhole Foot	518 538 514
161963		Blindstitch Guide	518 538 514 513 533
163990		Arm Shaft (horizontal) Thrust Washer	518 538 514 513 533

Part No	Price	Description	Machine
163990		Needle Bar Crank Thrust Washer	518 538 514 513 533
170065-001		Presser Bar Guide Bracket with 453-832	513 533
171163		Light Lead Control Bridge Retainer	513 533
171392		Straight Stitch Throat Plate	518 538 514
171498		Applique Foot	518 538 514 513 533
172007		Arm Spool Pin (packed with attachments)	518 538 514 513 533
172154		Bed Extension Locking Lever Spring	538 533
172203		Bed Cushion	538 533
172203		Bed Leg Cushion	538 533
172215-856		Tension Indicator Flange Adaptor	513 533
172218		Tension Indicator Flange Stop Washer	513 533
172226		Tension Disc	513 533
172228-855		Thread Take-up Spring Thread Guide	513 533
172336		Bobbin	518 538 514 513 533
172673		Arm Top Cover Thread Guide and Bobbin Winder Tension Bracket Support Retaining Ring	513 533
172673		Bobbin Winder Tension Bracket Support Retaining Ring	518 538 514
173669-453		Tension Indicator (Colour—Spec. No. 3152)	513 533
173670-453		Tension Indicator Flange (Colour—Spec. No. 3152)	513 533
173770-011		Bobbin Winder Pulley	518 538 514 513 533
179527		Bight Amplitude Bracket Hinge Pin	513 533
179529-819		Bight Amplitude Control Lever Clamping Plate	513 533
179564		Needle Bar Rocker Driving Arm Position Screw Stud	513 533
179565		Needle Bar Rocker with 50429-830	518 538 514 513 533
179566		Needle Bar Rocker Bracket	518 538 514 513 533

Part No.	Price	Description	Machine
179567		Needle Bar Rocker Collar with 50150-830	518 538 514 513 533
179572		Needle Bar Rocker Bracket Hinge Pin	518 538 514 513 533
179573		Needle Bar Rocker Tension Spring	518 538 514 513 533
179574		Needle Bar Rocker Thrust Washer	518 538 514 513 533
179580		Needle Position Selector Hinge Pin Collar	518 538 514 513 533
179591-821		Presser Bar Bushing	518 538 514 513 533
179602-855		Slack Thread Regulator and Tension Thread Guide	513 533
179615		Motor Insulating Bushing	518 538 514 513 533
179616		Motor Insulating Bushing Sleeve	518 538 514 513 533
179617		Motor Mounting Pin	518 538 514 513 533
179624		Tension Releasing Lever	513 533
276303		Disc No. 3 (Blindstitch)	518 538
276304		Disc No. 4 (Scallop Stitch)	518 538
276305		Disc No. 5 (Arrowhead Stitch)	518 538
276306		Disc No. 6 (Domino Stitch)	518 538
276307		Disc No. 7 (Shell Edge Stitch) (supplied at an extra charge)	518 538
276308		Disc No. 8 (Solid Scallop Stitch) (supplied at an extra charge)	518 538
276309		Disc No. 9 (Icicle Stitch) (supplied at an extra charge)	518 538
276310		Disc No. 10 (Banner Stitch) (supplied at an extra charge)	518 538
276311		Disc No. 11 (Key Stitch) (supplied at an extra charge)	518 538
276312		Disc No. 12 (Walls of Troy Stitch)	518 538
276313		Disc No. 13 (Diamond Stitch) (supplied at an extra charge)	518 538
276314		Disc No. 14 (Zig-Zag Point Stitch) (supplied at an extra charge)	518 538

Part No.	Price	Description	Machine
276315		Disc No. 15 (Long Oblique Stitch) (supplied at an extra charge)	518 538
276316		Disc No. 16 (Shingle Stitch) (supplied at an extra charge)	518 538
276317		Disc No. 17 (Pennant Stitch) (supplied at an extra charge)	518 538
276318		Disc No. 18 (Three-Step Stitch) (supplied at an extra charge)	518 538
276319		Disc No. 19 (Ball Stitch) (supplied at an extra charge)	518 538
276320		Disc No. 20 (Curved Mending Stitch) (supplied at an extra charge)	518 538
276321		Disc No. 21 (Thunderbird Stitch) (supplied at an extra charge)	518 538
276322		Disc No. 22 (Semaphore Stitch) (supplied at an extra charge)	518 538
276323		Disc No. 23 (Solid Pyramid Stitch) (supplied at an extra charge)	518 538
276324		Disc No. 24 (Open Pyramid Stitch) (supplied at an extra charge)	518 538
276325		Disc No. 25 (Spiny Stitch) (supplied at an extra charge)	518 538
276326		Disc No. 26 (Block Stitch) (supplied at an extra charge)	518 538
276327		Disc No. 27 (Faggoting Stitch) (supplied at an extra charge)	518 538
276328		Disc No. 28 (Comb Stitch) (supplied at an extra charge)	518 538
276329		Disc No. 29 (Pavilion Stitch) (supplied at an extra charge)	518 538
276330		Disc No. 30 (Platform Stitch) (supplied at an extra charge)	518 538
276331		Disc No. 31 (Crescent Stitch)	518 538
310706-451		Throat Plate (Finish—Spec. No. 1040)	518 538 514 513 533
310708-451		Presser Bar Lifter (Finish—Spec. No. 1051)	518 538 514 513 533
310717		Cam Controlled Feed Regulator Driving Bracket	518 538 514 513 533
310720		Feed Regulator Shaft	518 538 514 513 533

Part No.	Price	Description	Machine
310722		Feed Regulator Shaft Crank with 449-830	518 538 514 513 533
310723		Needle Position Dial Stud	518 538 514
310725-451		Belt Tension Adjuster Bracket (Finish—Spec. No. 1019)	518 538 514 513 533
310726		Belt Tension Pulley, complete, Nos. 136-803, 101558, 153344-883 and 310725-451	518 538 514 513 533
310731		Rotating Hook Flanged Bushing (eccentric)	518 538 514 513 533
310732		Rotating Hook Bevel Gear Spacer	518 538 514 513 533
310734-451		Cam Controlled Feed Cam Follower Lever Hinge Screw Stud (Finish—Spec. No. 1003)	518 538 514
310739-451		Bed Slide (Finish—Spec. No. 1039)	518 514 513
310744		Needle Bar Stop and Thread Guide	518 538 514
310753		Feed Lifting Cam and Feed Eccentric with two 140321-830	518 538 514 513 533
310757		Needle Bar Rocker Driving Arm Follower	518 538 514 513 533
310761-451		Bobbin Winder Tension Disc Stud (Finish—Spec. No. 1056)	518 538 514
310762-451		Bobbin Winder Tension Support (adjustable) (Colour—Spec. No. 3152)	518 538 514
310763-451		Bobbin Winder Tension, complete, Nos. 45847, 172673, 310761-451, 310762-451 and two 45915-855	518 538 514
310764-451		Disc Follower Disengaging Lever Adjusting Plate (Finish—Spec. No. 1019)	514
310765-451		Disc Selector Dial (Colour—Spec. No. 3153)	514
310776		Bed Cover Plate (bottom) with 103967	518 514 513
310777-451		Bed End Cover Plate (Colour—Spec. No. 3152)	538 533
310778-451		Arm Top Cover Thread Guide (Finish—Spec. No. 1055)	518 538 514
310779-451		Hand Wheel (Colour—Spec. No. 3152)	513 533
310791-451		Throat Plate Clamp (Finish—Spec. No. 1040)	518 538 514 513 533
310797		Arm Shaft (horizontal)	518 538 514 513 533

Part No.	Price	Description	Machine
310808-451		Arm End Cover Plate (Colour—Spec. No. 3151)	513 533
310814		Disc Follower Disengaging Lever Adjusting Plate Screw Nut Washer	514
310817-451		Feed Regulator Mechanism Mounting Plate (Finish— Spec. No. 1019)	518 538 514 513 533
310826-452		Buttonholer and Feed Regulator Control Dial (Colour— Spec. No. 3319)	518 538 514
310828		Buttonholer and Feed Regulator Cam	518 538 514 513 533
310836-451		Disc Releasing Dial Return Spring Adjusting Plate (Finish—Spec. No. 1019)	518 538
310837		Disc Releasing Dial Return Spring	518 538
310842-451		Disc Release Disengaging Lever (Finish—Spec. No. 1019)	518 538
310843-451		Disc Releasing Dial (Colour—Spec. No. 3154)	518 538
310845		Disc Release Disengaging Lever Bracket Connection Extension	518 538
310846-451		Disc Releasing Lever Follower Screw Adjuster (Finish— Spec. No. 1050)	518 538
310847-451		Needle Clamp Body (Finish—Spec. No. 1055)	518 538 514 513 533
310848		Needle Clamp Body 310847-451 with 140751-851	518 538 514 513 533
310858-451		Hand Wheel (Colour—Spec. No. 3152)	518 538 514
310873		Feed Regulator Cam Follower Guide Pin and Mounting Plate Spacer Stud	518 538 514 513 533
310885		Rotating Hook Bobbin Case	518 538 514 513 533
310887-452		Cam Controlled Feed Dial (Colour—Spec. No. 3152)	518 538 514 513 533
310891-451		Control Panel (Colour—Spec. No. 3319) with two 103761	513
310897		Disc Selector Dial Positioning Spring	514
310901		Disc No. 242	518 538
310902-452		Arm Top Cover (Colour—Spec. No. 3152)	513 533

Part No.	Price	Description	Machine
310908-451		Rotating Hook Bobbin Case Retaining Plate (Finish—Spec. No. 1098)	518 538 514 513 533
310914-451		Feed Regulator Positioning Pin Knob (Colour—Spec. No. 3319) with 460-830	513 533
310915-451		Needle Bar Stop and Thread Guide Plate (Finish—Spec. No. 1055)	518 538 514
310920		Disc No. 243	518 538
319563		Hand Wheel Retaining Ring	518 538 514
319721-452		Needle Clamp Body Thread Guide (Finish—Spec. No. 1055)	513 533
319735		Rotating Hook Bobbin Case Retaining Plate Stud Spring	518 538 514 513 533
319736		Rotating Hook Bobbin Case Retaining Plate Stud Clip	518 538 514 513 533
319737		Rotating Hook Bobbin Case Retaining Plate Stud Washer	518 538 514 513 533
354015-451		Cam Controlled Feed Disengaging Lever Guide Screw (Finish—Spec. No. 1003)	518 538 514
354085-451		Feed Drive Shaft Bushing (front) Set Screw (Finish—Spec. No. 1019)	518 538 514 513 533
354085-451		Tension Stud Set Screw (Finish—Spec. No. 1019)	518 538 514
354112-451		Disc Follower Disengaging Lever Adjusting Plate Screw (Finish—Spec. No. 1003)	514
354127-451		Disc Releasing Dial Hinge Screw (Finish—Spec. No. 1019)	518 538
354133-451		Rotating Hook Flanged Bushing (eccentric) Position Adjusting Screw (Finish—Spec. No. 1003)	518 538 514 513 533
354134-451		Bed Slide Spring Screw (Finish—Spec. No. 1019)	518 538 514 513 533
354135-451		Presser Foot Thumb Screw (Finish—Spec. No. 1091)	518 538 514 513 533
354227-451		Rotating Hook Bobbin Case Position Plate and Retaining Plate (adjustable) Screw (Finish—Spec. No. 1090)	518 538 514 513 533
354229-451		Rotating Hook Bobbin Case Position Plate and Retaining Plate (adjustable) Adjusting Screw (Finish—Spec. No. 1090)	518 538 514 513 533
354229-451		Rotating Hook Bobbin Case Position Plate Screw (Finish—Spec. No. 1090)	518 538 514 513 533

Part No.	Price	Description	Machine
381085		Attachment Set, complete, Nos. 103473, 103486, 153267, 153829, 153831, 161927, 161963, 171392, 171498, 276303, 276304, 276305, 276306, 276312, 276331, 310901, 310920, 507836 and three 172336	518
381086		Attachment Set, complete, Nos. 103473, 103486, 153267, 161927, 161963, 171392, 171498, 507836 and three 172336	514
381087		Attachment Set, complete, Nos. 103473, 103486, 161963, 171498, 507836 and three 172336	513
381903-451		Rotating Hook Bobbin Case Retaining Plate (adjustable) (Finish—Spec. No. 1080)	518 538 514 513 533
500391-830		Feed Regulator Set Screw	518 538 514 513 533
501723		Bed Extension Locking Lever Pivot Screw Supporting Disc	538 533
506468		Feed Regulator and Slide Block with 500391-830	518 538 514 513 533
507063		Feed Bar Connection Ball Bearing Retaining Ring	518 538 514 513 533
507063		Feed Lifting Fork Connection Retaining Ring	518 538 514 513 533
507064		Bed Leg Position Pin	538 533
507680		Feed Bar Guide (eccentric) Centre (front)	518 538 514 513 533
507722		Feed Bar Connection Spring Washer	518 538 514 513 533
507806		Even Feed Foot (supplied at an extra charge)	518 538 514 513 533
507836		Zipper Foot	518 538 514 513 533
511016		Feed Lifting Fork Connection	518 538 514 513 533
511018		Bed Extension Locking Lever	538 533
511021		Bed Extension Locking Lever Pivot	538 533
511024		Feed Regulator Shaft Bushing	518 538 514 513 533
511039		Feed Regulator Shaft Collar with 50311-830	518 538 514 513 533
511044-451		Feed Bar Connection and Feed Lifting Fork Connection Hinge Stud (eccentric) (Finish—Spec. No. 1003)	518 538 514 513 533
511056-451		Feed Lifting Fork Connection Hinge Stud (eccentric) (Finish—Spec. No. 1003)	518 538 514 513 533

Part No.	Price	Description	Machine
511057-451		Feed Lifting Fork Hinge Stud (Finish—Spec. No. 1003)	518 538 514 513 533
511183		Feed Bar	518 538 514 513 533
511213		Feed Bar Connection and Feed Lifting Fork Connection Hinge Stud (eccentric) Retaining Ring	518 538 514 513 533
511213		Feed Lifting Fork Hinge Stud Retaining Ring	518 538 514 513 533
511213		Feed Regulator Slide Block Stud Retaining Ring	518 538 514 513 533
511213		Disc Follower Disengaging Lever Retainer	514
511233-451		Feed Bar Guide Pin (eccentric) Centre (back) (Finish—Spec. No. 1003)	518 538 514 513 533
511435		Feed Lifting Cam and Feed Eccentric Retaining Ring	518 538 514 513 533
511482		Feed Bar Connection and Feed Regulator Slide Block Drive Connection with 511213	518 538 514 513 533
514607-451		Buttonholer Needle Position Dial Connection Link Hinge Screw Nut (Finish—Spec. No. 1019)	518 538 514
514607-451		Disc Follower Disengaging Lever Adjusting Plate Screw Nut (Finish—Spec. No. 1019)	514
514607-451		Disc Releasing Lever Follower Screw Nut (Finish—Spec. No. 1019)	518 538
514607-451		Disc Selector Rocker Arm Follower Screw Nut (Finish—Spec. No. 1019)	514
603975-003		Motor Belt	518 538 514 513 533
618177-002		Motor Pinion Tolerance Ring	518 538 514 513 533
885882-002		Brush	518 538 514 513 533
885888		Brush Spring	518 538 514 513 533